

SURROUND YOURSELF with SAFETY

TECHNICAL DOCUMENTATION



SAFETY MATS

The sensitive mat is a safety component, featuring an electro-pressure sensible element to detect the presence of people.

The presence of people over 35 kg closes a contact inside the sensor.

The state change of the internal sensor (NO to NC) is processed by the control unit "control device" that sends a machine stop signal and eliminates the danger situation.

HOW TO DIMENSION A MAT

The minimum distance of the dangerous zone must be calculated using the general formula

$$S = (K \times T) + C$$

whereas:

S=minimum distance in mm, of the dangerous zone at the point, axis or plan of the detection zone.

K=Constant in mm/s, derived from data on speeds of body approach.

T= Global response time in sec.

C=Supplementary distance in mm, based on the intrusion into the dangerous zone before activating the protection device.

CALCULATION OF MINIMUM DISTANCE FOR SENSITIVE DEVICES INSTALLED ON THE FLOOR

General method

The choice and use of sensitive devices installed on the floor, activated by foot, depend upon the standard "C" appropriate or an evaluation of risks according to EN ISO 12100 if no C standard exists.

Examples of sensible devices installed on the floor include the sensitive mats, sensitive to pressure, and optoelectric protection devices. The minimum distances derived in this point for sensitive devices installed on the floor require that the approaching speed to the dangerous zone is the walking speed. Referring to the risk of bypassing the detection zone, see appendix B (standard Uni EN 999). The minimum distance is calculated according to the formula:

$$S = (1600\text{mm/s} \times T) + (1200\text{mm} - 0,4 H)$$

whereas:

H=Distance over the reference plan, ex. floor, in mm.

Floor installation

In most cases the sensitive device is assembled directly on the floor, i.e. H=0. Therefore, the minimum distance for sensitive devices installed on the floor is calculated according to the formula:

$$S = (1600\text{mm/s} \times T) + 1200\text{mm}.$$

Example

Approaching direction to detection zone.

This minimum distance is calculated according to the formula:

$$S = (K \times T) + C$$

whereas:

K= 1600mm/s

C= 1200mm - 0,4 H, but not less than 850mm, whereas H is the height of the detection zone over the reference plan (ex. floor) in mm.

That is:

$$S = (1600\text{mm/s} \times T) + (1200\text{mm} - 0,4 H)$$

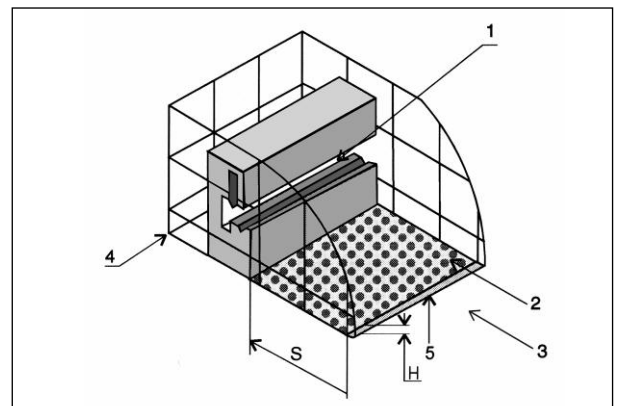

H = Height of measuring zone over reference table.

S = Minimum distance.

1 = Dangerous zone.

2 = Detection zone.

3 = Approach direction

4 = Stationary cover

5 = Start of measuring zone

TYPES OF MATS

Coating

The mat can be supplied with 2 coatings:

- Black embossed PVC (other colours upon request)
- PVC coated with almond shaped aluminium (ex. machines processing incandescent materials)

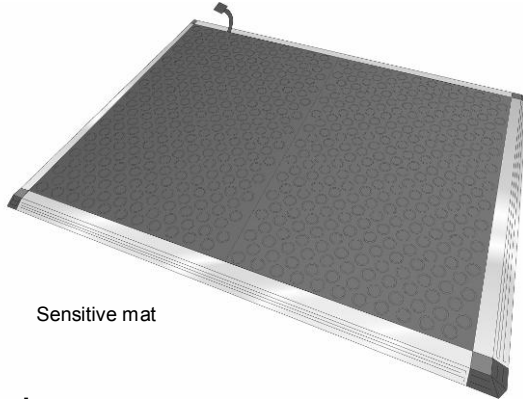

Sensitive mat

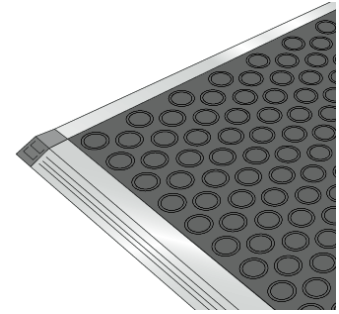

Embossed PVC

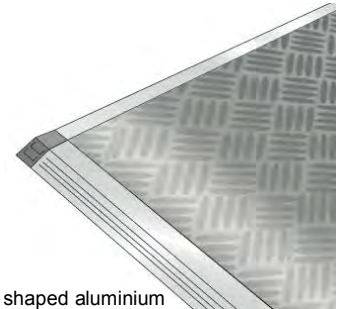

Mandle shaped aluminium

Versions

The mat is available in 2 versions:

1-“STANDARD MAT”

Dimensions upon request, profiles fastened to the mat, with the possibility of PVC or aluminium coating.

Upon request, the aluminium profiles can be supplied loose, tailor-made.

The PVC coated mat can be:

- mounted on plate to give more rigidity to the mat
- with **2 (two) sensitive zones**, controlled by 2 separate circuits (ex. opening of a door with the presence of a person, or in front of a bank teller). In this case, if the 2 zones are taken simultaneously, the signals stop the system.

Maximum dimensions of single mat: 3000x1500 mm. You can shape larger surfaces using more mats.

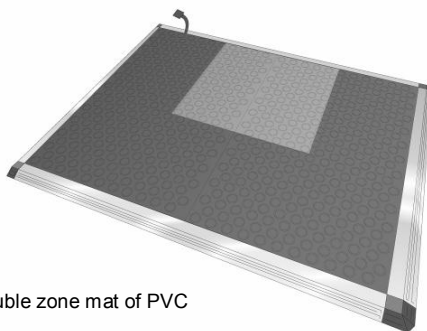

Double zone mat of PVC

The following profiles are available, to be specified in the order:

For mats with PVC coating:

- Type “A” slope profile
- Type “B” 90° profile

For mats with aluminium coating and mat mounted on plate:

- Type “GSPSA” slope profile
- Type “GSP90A” 90° profile
- Type “GSPCA” profile with cable channel

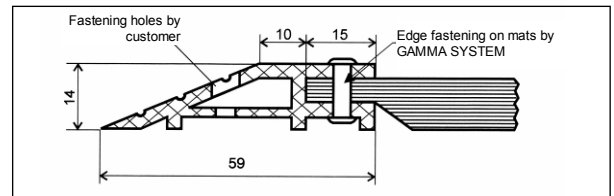

Slope profile type A

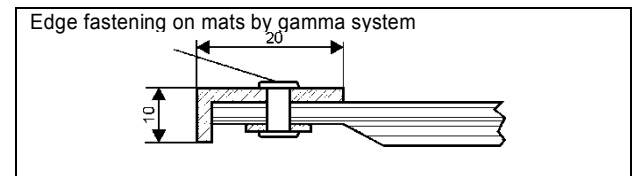

90° profile type B

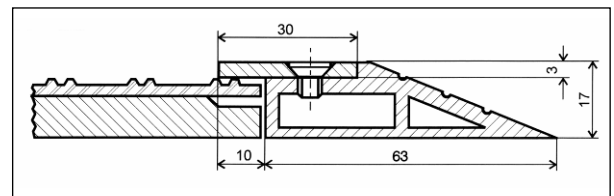

Slope profile type “GSPSA”

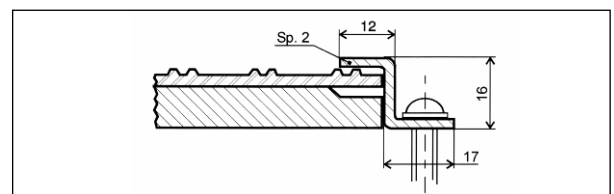

90° profile ° type “GSP90A”

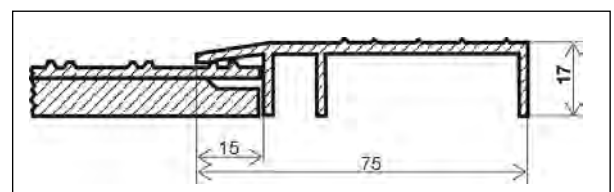

90° profile with cable carrying channel type “GSPCA”

The mat features a 4 poles outlet cable 4*0,35mm² FROR 300/500 standard length m 3.

How to order the standard sensitive mat:
The dimension always include the profiles.
 Always attach a drawing of the mat, indicating the dimensions (L=width x H=length), profiles and cable outlet position, if different from the standard one.

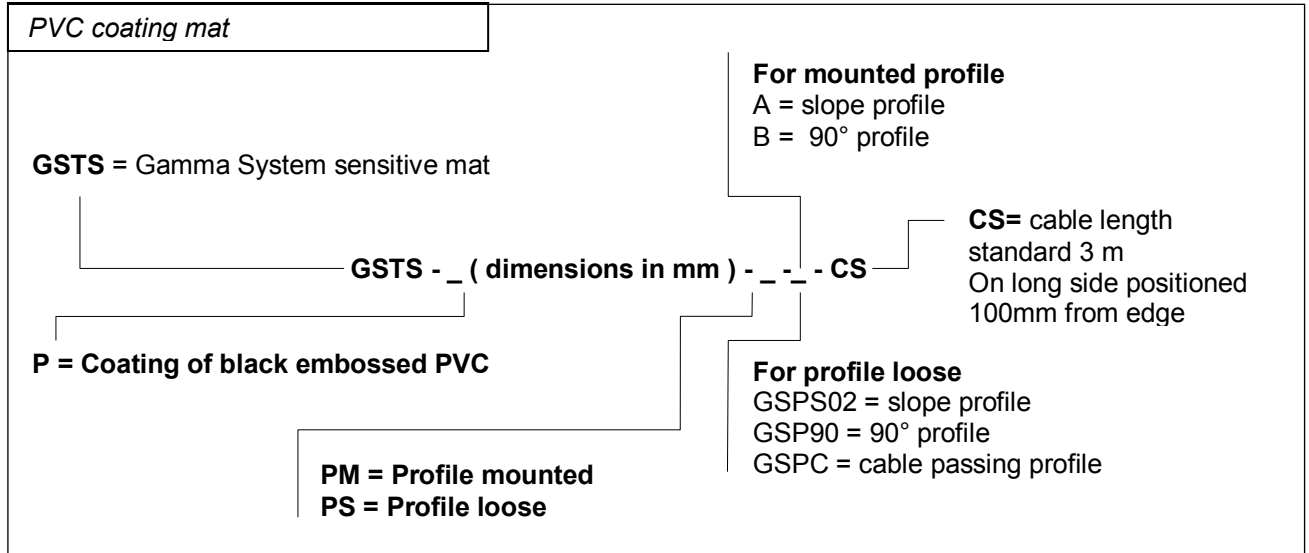

Example:

GSTS-P (L)1000x(H)500-PM-A-CS

(mat coated with PVC 1000x500 slope profile on 4 sides with standard cable outlet).

Example:

GSTS-P (L)1000x(H)500-PS-GSPS02-CS

(mat coated with PVC 1000x500 profile loose, slope on 4 sides, with standard cable outlet).

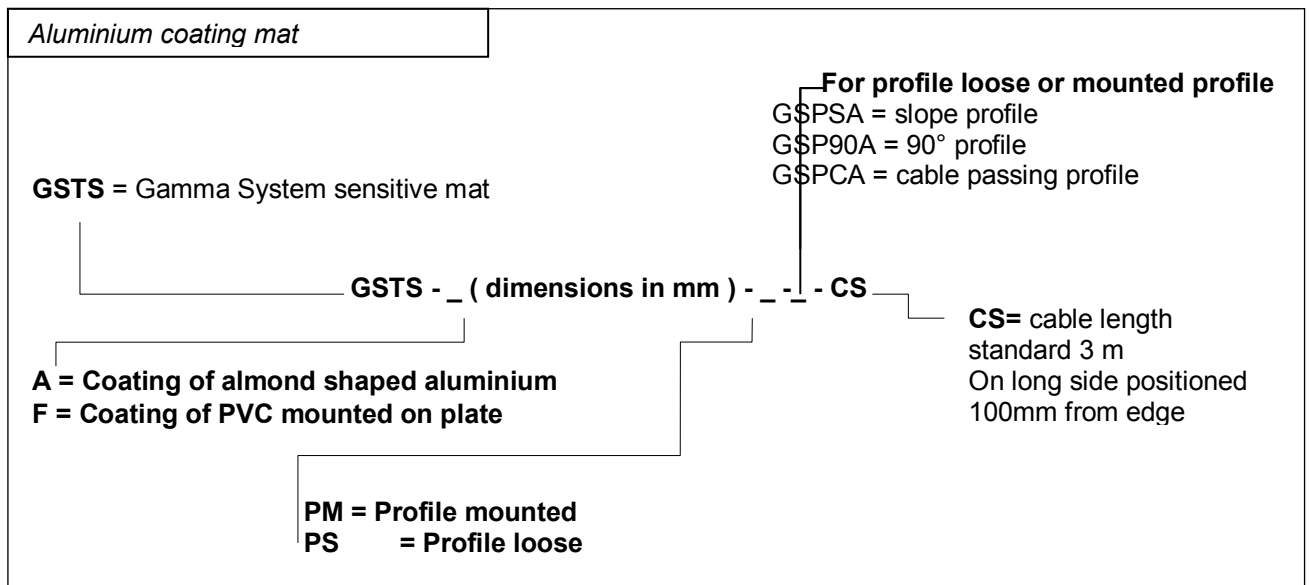

Example:

GSTS-A-(L)1000x(H)500-PM-G\$PSA-CS

(mat coated with ALUMINUM 1000x500 slope profile on 4 sides, with standard cable outlet).

2- "MODULAR MAT"

PVC coating only, standard dimensions and loose profiles.

Solution of transport, handling and installation problems.

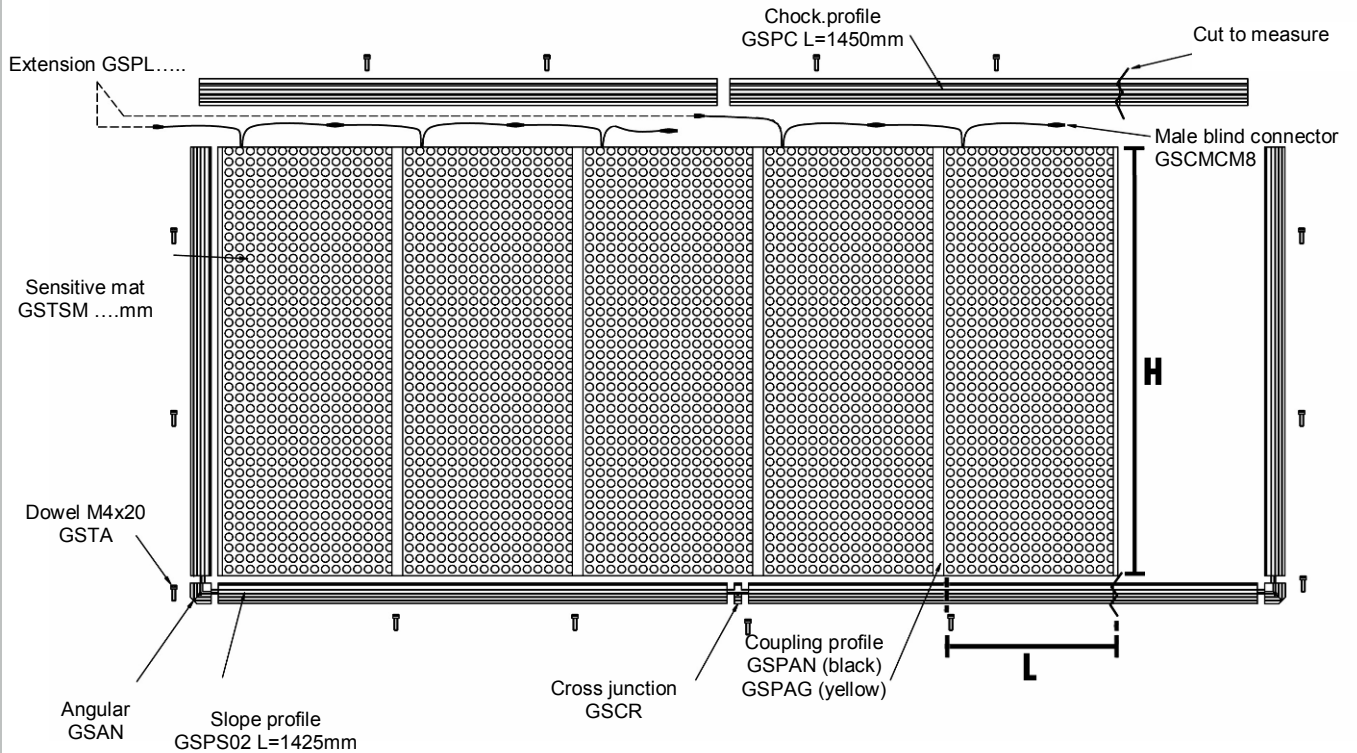

Standard dimensions:

In the modular mat's version the dimension is the sensible part of mats, profile excluded.

Standard width (L): 500, 750, 1000 mm
Standard length (H): 1000, 1400, 1600 mm

The profiles required to fasten the mat are supplied loose and must be ordered separately.

Four profiles are available:

- cod. GSPS02 slope profile L= mm 1425
- cod. GSPC cable passing profile L= mm 1450
- cod. GSP90 90° profile L= mm 1600
- cod. GSPAN (black) or GSPAG (yellow)
PVC coupling profile of 2 mats L= mm 1600

The supply must include:

- cod. GSCR cross junction (pack of 5 pcs)
- cod. GSAN angular (pack of 3 pcs)
- cod. GSTA anchorage dowels (pack of 10 pcs)

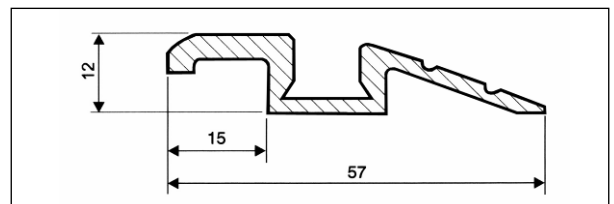
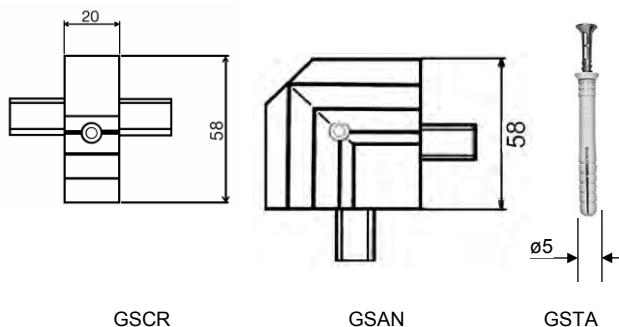

Slope profile cod. GSPS 02

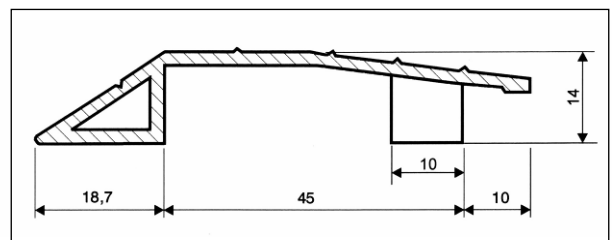

Cable passing profile cod. GSPC

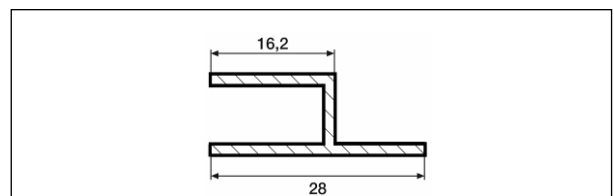

90° profile cod. GSP90

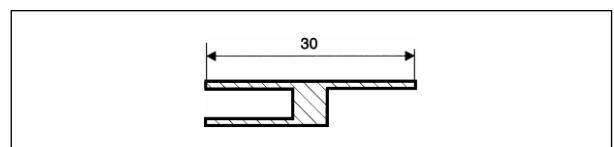

Coupling profile
cod. GSPAN (PVC black)
cod. GSPAG (PVC yellow)

The mat is supplied with 2 outlet cables L=600mm 4 poles 4*0,25mm² CEI IP65 one with die-cast connector M8 MALE and the other with connector M8 FEMALE for series connection of the mats.

Electrical connection between mat and device

For the electrical connection, order an extension with connector M8 FEMALE (cod. GSPL) and an electric circuit closing connector (cod. GSCMCM8).

How to order a modular sensible mat

Example of a mat 2 zones, dimensions of the zone to be covered 2500 x 1000 mm (fig. page 5).

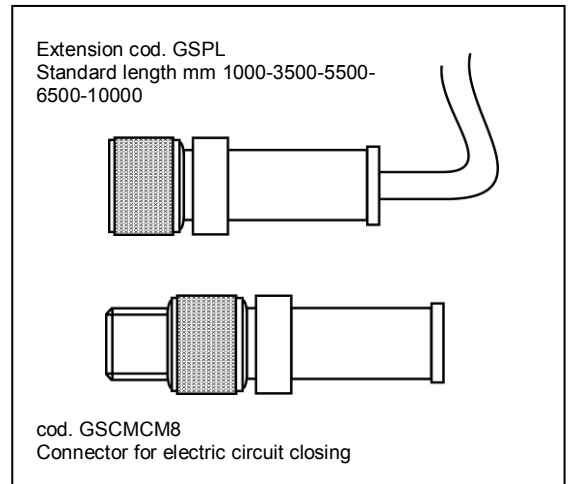

GSTSM= Gamma System modular sensitive mat

N° _ GSTSM (L x H dimensions in mm)

Quantity/number of mats

Example:

n. 5 GSTSM (L)500x(H)1000 mm

Edges with relative quantity

- cod. GSPS02 slope profile L= mm 1425
- cod. GSPC chock profile L= mm 1450
- cod. GSP90 90° profile L= mm 1600
- cod. GSPAN (black) or GSPAG (yellow) coupling PVC profile of 2 mats L= mm 1600 (Es. n.04 GSPS02 + n.02 GSPC +n.02 GSPAN + n.01 GSPAG)

Accessories for profiles

- cod. GSCR cross junction (pack of 5 pcs)
- cod. GSAN angular (pack of 3 pcs)
- cod. GSTA anchorage dowels (pack of 10 pcs) (Es. n.01 pack. GSCR + n. 01 pack. GSAN + n. 02 pack. GSTA)

Accessories for electrical connections

- cod. GSCMCM8 male blind connector for circuit closing.
- cod. GSPL (mm 1000 - 3500 - 5500 - 6500 - 10000) extension of mat connection to safety device (Ex. n. 02 GSCMCM8 + n. 02 GSPL3500)

TECHNICAL FEATURES

(Combined with control units GP02/E-GP02R.T)

Description	Mat with PVC coating	
Material	PVC	
Max thickness	10 mm	
Weight/m ²	15 Kg (approx.)	
Operating pressure	< 300 N Ø mm 80 / < 600 N Ø mm 200	
Max admissible load	2000 N / 80 Ø mm (avoid manoeuvres with heavy means such as lift trucks, motor vehicles and alike).	
Response time with Gamma System control units	Single sensor: ≤ 60 ms	
	Combination of sensors: ≤ 124 ms	
Mechanical life of internal contact	2,000,000 operations	
Max operating voltage	24 Vdc/ac	
Max operating current	60 mA / 24 V	
Electric resistance of sensor/m ²	1,7 Ω/m ²	
Linear resistance of cable	0,056 Ω/m	
Max connection length	100 m	
Connection cable section	min. 0,35 mm ² For cables with L>20 m min. 1 mm ² .	
Output contact	NO	
Operating temperature	+5°C to 60°C	
Degree of protection	IP65	
Chemical resistance	Oils, hydrocarbons, diesel oil	
Reference Standards	EN 1760-1:1997 + A1:2009, EN ISO 13849-1	
Safety Parameters	GSTS01 sensor combined with GP02/E	GSTS01 sensor combined with GP02R.T
Category	3	3
PL	e	e
PFH	8,58*10 ⁻⁸	8,58*10 ⁻⁸
No. of operations/year	35000	50000
EC-TYPE Certification	10DM4SA108	11DM4SC14
Usage categories	DC13(24) – 1,5 A AC1(230) – 3 A	AC15(230) – 1,2A
Mission time [years]	20	
Max dimensions of each safety mat	1500 x 3000 mm	
Max controllable surface	m ² 5	m ² 10
Dead zone	Welding peripheral zone 15mm	

CONTROL UNIT/DEVICE TO CONTROL MATS EDGES AND SHOCK ABSORBERS

The control unit is a device to control the function of a sensor (mat, edge or shock absorber) by blade contacts.

The blade contact is a NO contact that closes, causing the opening of the outlet contact of the control unit.

The control unit controls the operation of the sensor and the connection circuit, and allows to

transform the NO signal of the blade contact into a NC safety signal.

A control device can control several sensors, but cannot perform the auto-diagnose indicating which sensor is faulty. If more sensors are used, use a control unit every 3-4 sensors.

MODELS AVAILABLE:

GP02/E

GP02R.T – GP02R.T1

GP02R and GP02R-C Only for edges with electrical resistance 8,2kΩ

CONTROL UNIT

Description

Emergency stop circuit, used to manage and control a sensor, having two safety relays terminals with forced opening contacts.

The two relays, normally excited, are deenergized in the following conditions:

- No supply
- Operation of mat, edge, shock absorber.
- Internal faults
- Interruption of the internal circuit of mat, edge, shock absorber or connection cables between control unit and sensor (mat, edge, shock absorber).

The devices are supplied with **automatic reset** but they can be transformed into **manual reset**.

If a control unit is used **without rearming** the function must be supplied by the control system of the machine (see std. EN 13849-1).

Operation

Two separate channels detect the voltage at the end of the safety terminals of the mat, and each channel commutes a safety relay with forced opening contacts.

Models GP02/E- GP02R.T(automatic restart)- GP02R.T1(manual restart)

The supply voltage is limited by a specific group and the pilot circuit, to avoid short circuit currents while closing the sensor (mat, edge, shock absorber). The control unit controls itself, as well as any other operation.

Inlet terminals are foreseen for:





- Test signal activating/deactivating the circuit of the control device simulating the operation of the sensor and checking the system efficiency.
- Signal of manual reset/ feedback-action.

The two modules are differentiated by the number of outlet contacts: model GP02/E has a NO safety contact, whereas model GP02/E-S2 and GP02R.T has two NO safety contacts.

Model GP02R and GP02R-C only for edges with electrical resistance 8,2kΩ

Two symmetric circuits detect the current in the edge, adjusted for a resistance of 8,2 kΩ. When the circuits detect a variation of ± 4 kΩ, caused by a fault or operation of the edge, they desexcite the outlet relays, that open the safety contacts.

TECHNICAL FEATURES

	TYPE GP02/E	TYPE GP02R.T	TYPE GP02R 8,2k Ω	TYPE GP02R-C 8,2k Ω
Reference Standards: EN ISO13849-1, EN1760-EN60947-5-1 EN 50205 (type A)				
PL	e			
Category	3			
PFH (1/h)	4,29*10 ⁻⁸			
No. of operations/year	35000	50000	5000	5000
Usage categories	DC13(24) – 1,5 A AC1(230) – 3A	AC15(230) – 1,2 A	AC15(230) -4 A	AC15(230) – 3A DC13(24) – 3A
Mission time [years]	20			
Electrical data				
Supply voltage	24 VDC \pm 10%			
Current consumption with mat activated (24VDC)	15 mA			
Current consumption with reset module 24VDC)	90 mA			
Internal protection of power supply	YES (1 A)			
Inputs				
Input short-circuit detection	YES			
Input connection interruption detection	YES			
Max length of connection cables	100 m			
Min section of connection cables	0,35 mm ² (1mm ² L>20m)			
Max resistance of sensor	100 ohm	40 ohm		
Voltage applied to inputs	24 VDC			
Max current (peak value)	200 mA			
Safety outputs				
Number of safety outputs	1 NO	2 NO		
Rated voltage/Max switchable voltage VAC	250/400	230/300		
Rated current	6 A	AC15 230 VAC 1,5A DC13 24VDC 1,2 A		
Material of standard contacts	AgNi	AgSnO ₂		
Rated supply voltage	V AC50/60hz	-		
	V DC	24		
Rated power AC/DC VA (50 Hz)/W	-/0,7	-/0,25		
Delay to energizing (reset)	25 ms (typical)	12 ms		
Delay to de-energizing (trip)	10 ms (typical)	13 ms		
Protection against over-current	4 A quick-action/2 A delayed			
Mechanical life	10 ⁹	10 ⁷		
Signal outputs				
Number of signal outputs	1			
Max operating voltage	VAC	125		
	VDC	30		
Max current 110VAC	0,2A			
Max current 24VDC	0,5A			
Environmental characteristics				
Operating temperature [°C]	0 / 55	-25 /+50		
Storage temperature [°C]	-20 /+70	-25 /+70		
Max relative humidity	85%			
Degree of protection of terminals	IP20			
Degree of protection of casing	IP30			IP65
Dimensions				
Width [mm]	35	22,5	120	
Height [mm]	90	114	75	
Depth [mm]	70	99	155	
Weight [g]	150	140	410	
Material of the casing	ABS	PA66-FR	GW PLAST 75	
Installation	ON 35 mm Omega rail			
EC-TYPE CERTIFICATION	RP10DM4SA113	RP11DM4SC12	RP10M4SA107	

10044 Pianezza – TO – Via Torino, 24/I – ITALY
Tel. +39 011 968 24 66 r.a. – Fax +39 011 967 42 11
e-mail: info@gammasystem.com
www.gammasystem.com

